

EuroVan - Standard Equipment, only for cars with blue illuminated instrument cluster

from September 1998

Deviate relay location and fuseplacements as well as the locations of multiple connectors see section "component locations".

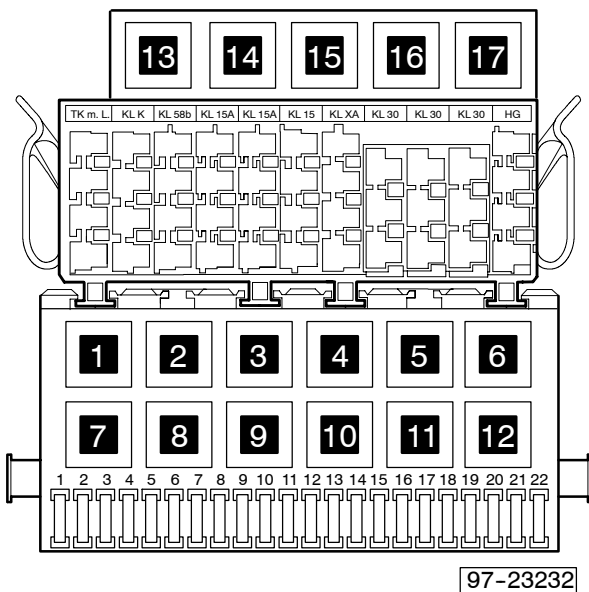

- 2** Rear Window Wiper/Washer Relay (174)
- 4** Load Reduction Relay (18)
- 8** Wiper/Washer Intermittent Relay (programmable) (99)
- 11** Dual Horn Relay (53)
- 17** Load Reduction Relay II (53)

Note: Number in parentheses indicates production control number stamped on relay housing.

Fuse colors

- 30 A - green
- 25 A - white
- 20 A - yellow
- 15 A - blue
- 10 A - red
- 7,5 A - brown
- 5 A - beige
- 3 A - violet

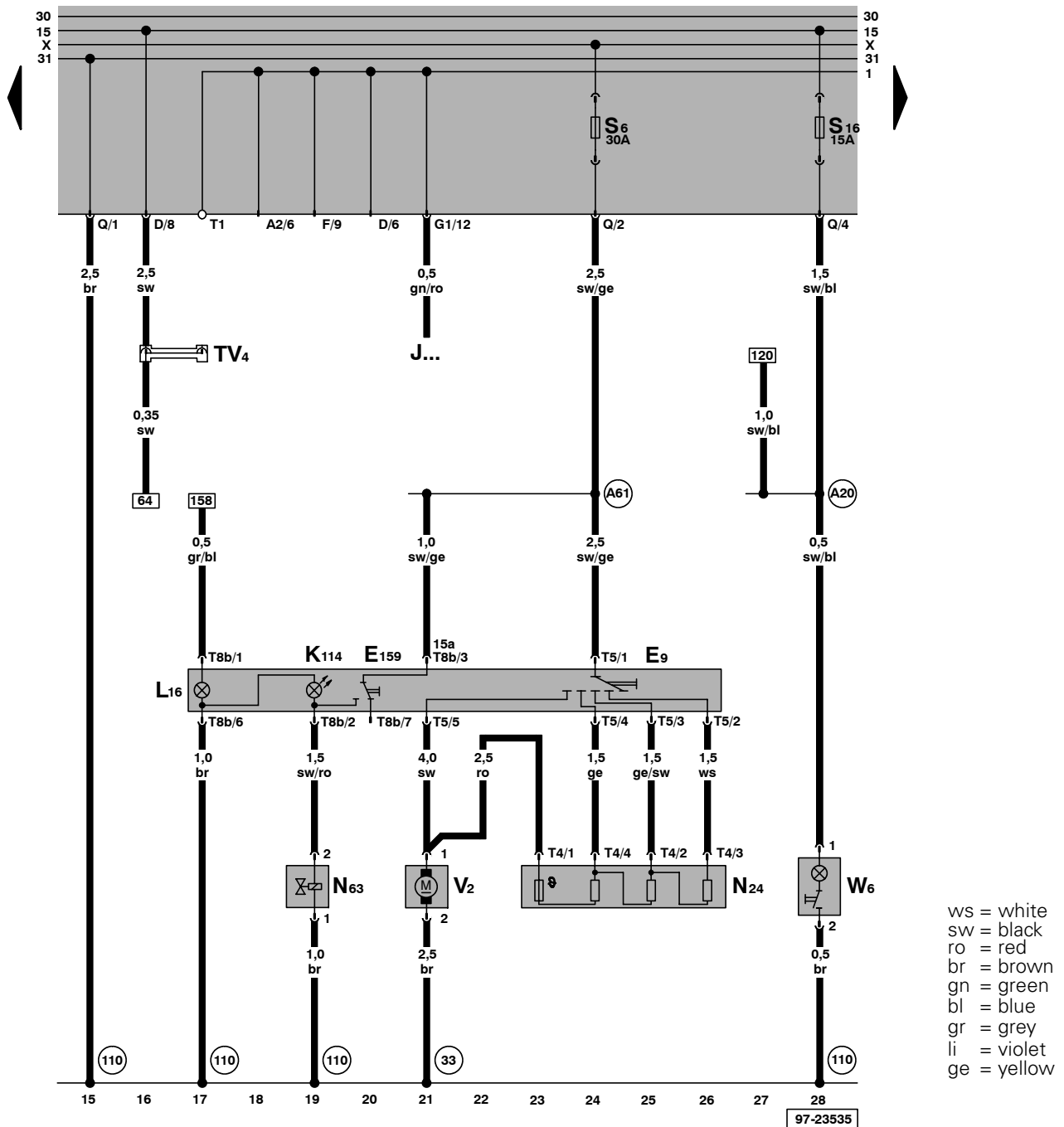

- E9 - Fresh Air Blower Switch
 E159 - Fresh Air/Recirculating Flap Switch
 J... - Engine Control Module (ECM)
 K114 - Fresh Air and Recirculating Air Mode Indicator Light
 L16 - Fresh Air Control Lever Light
 N24 - Fresh Air Blower Series Resistance with Fuse
 N63 - Fresh Air/Recirculating Flap Two-Way Valve
 T4 - 4-Pin Connector
 T5 - 5-Pin Connector
 T8b - 8-Pin Connector
 TV4 - Terminal 15 Wire Connector, black
 V2 - Fresh Air Blower
 W6 - Glove Compartment Light

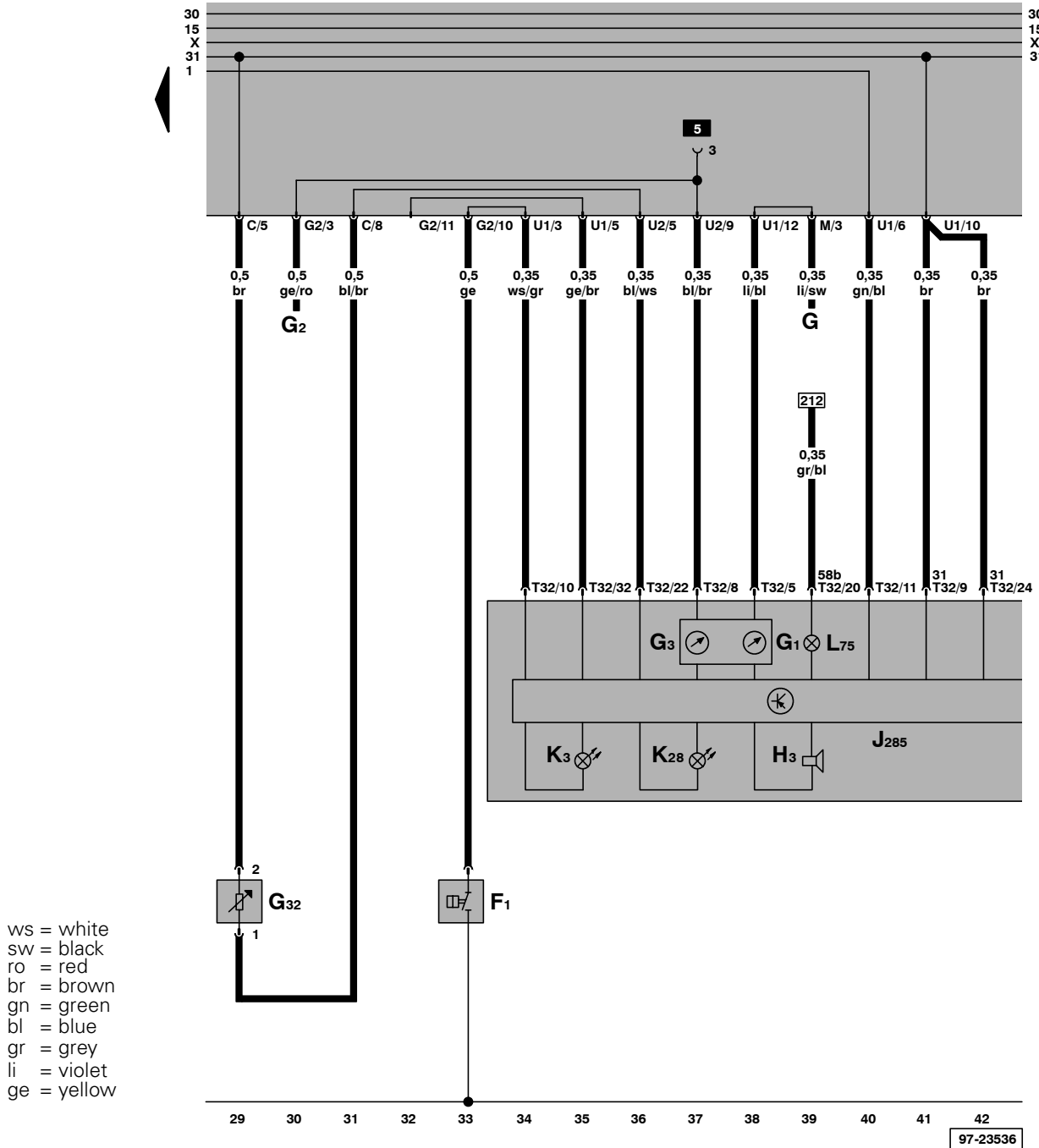

- F1 - Oil Pressure Switch
- G - Fuel Level Sensor
- G1 - Fuel Gauge
- G2 - Engine Coolant Temperature (ECT) Sensor
- G3 - Engine Coolant Temperature (ECT) Gauge
- G32 - Engine Coolant Level (ECL) Sensor
- H3 - Warning Buzzer
- J285 - Control module with indicator unit in instrument panel insert
- K3 - Oil Pressure Warning Light
- K28 - Engine Coolant Level/Temperature (ECL/ECT) Warning Light
- L75 - Digital Display Light
- T32 - 32-Pin Connector, blue

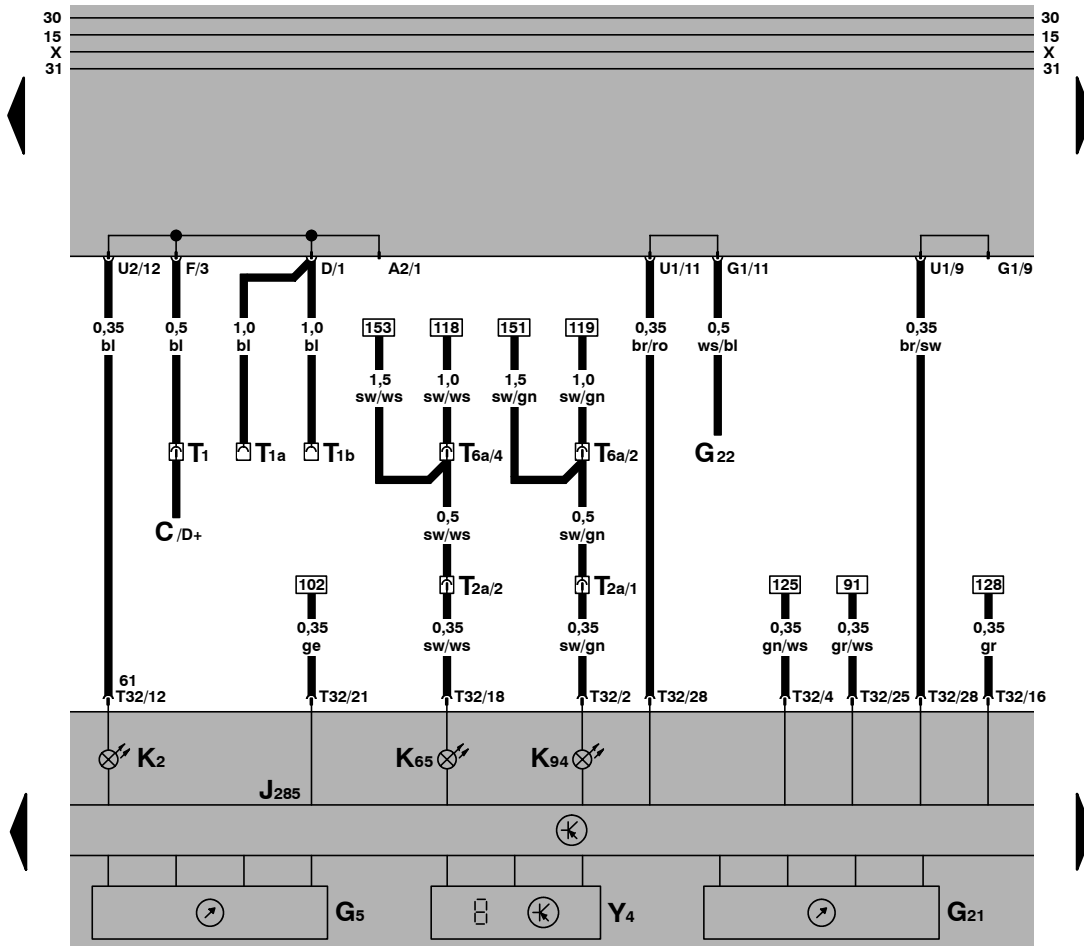

ws = white
 sw = black
 ro = red
 br = brown
 gn = green
 bl = blue
 gr = grey
 li = violet
 ge = yellow

43 44 45 46 47 48 49 50 51 52 53 54 55 56
 97-23537

- C - Generator (GEN)
- G5 - Tachometer
- G21 - Speedometer
- G22 - Speedometer Vehicle Speed Sensor (VSS)
- J285 - Control module with indicator unit in instrument panel insert
- K2 - Generator (GEN) Warning Light
- K65 - Left Turn Signal Indicator Light
- K94 - Right Turn Signal Indicator Light
- T1 - Single Connector, near starter
- T1a - Single Connector, behind fuse/relay panel
- T1b - Single Connector, behind fuse/relay panel
- T2a - Double Connector, behind fuse/relay panel
- T6a - 6-Pin Connector, behind fuse/relay panel
- T32 - 32-Pin Connector, blue
- Y4 - Odometer Display

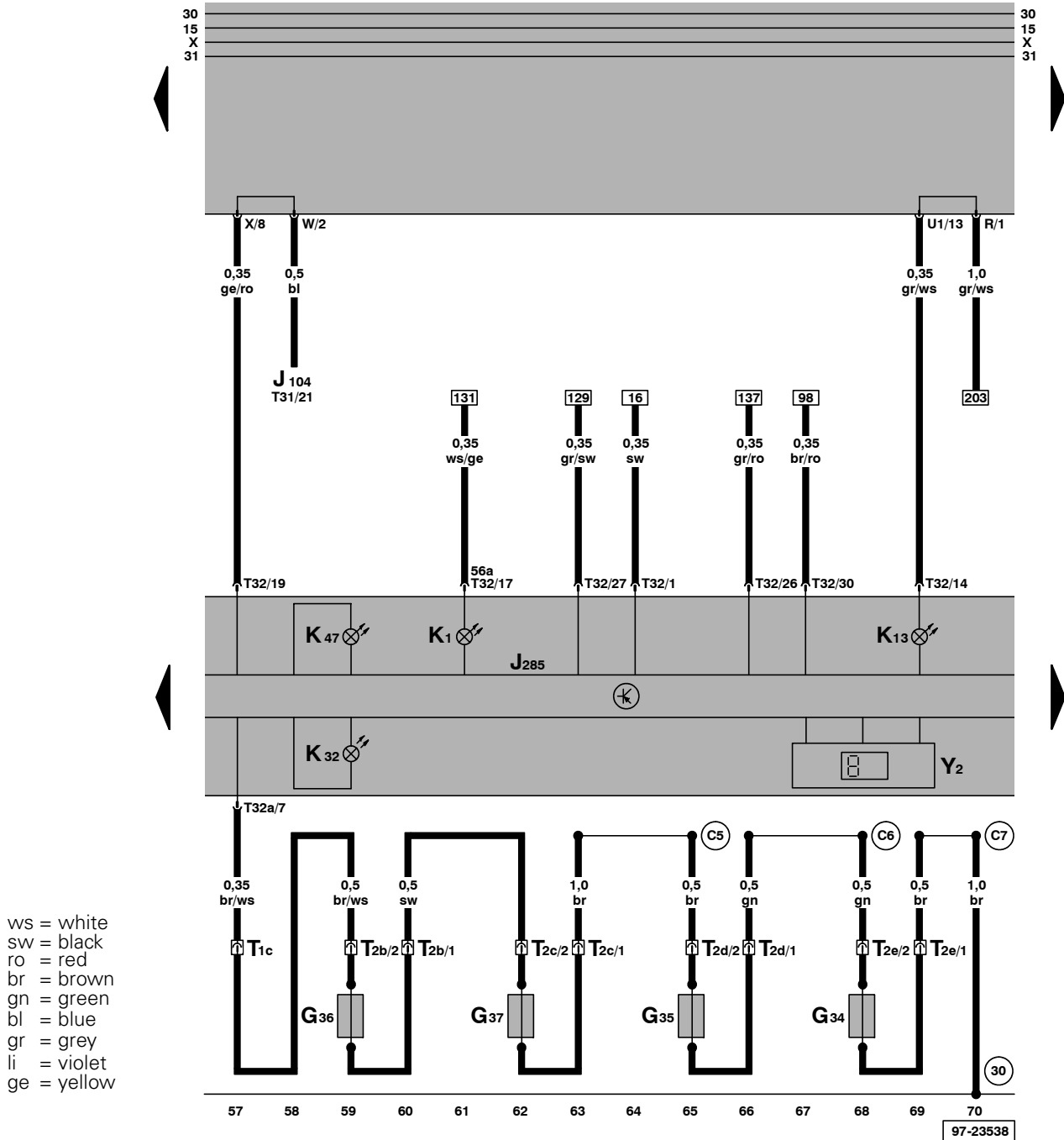

- G34 - Left Front Brake Pad Wear Sensor
- G35 - Right Front Brake Pad Wear Sensor
- G36 - Left Rear Brake Pad Wear Sensor
- G37 - Right Rear Brake Pad Wear Sensor
- J104 - ABS Control Module (w/EDL), in engine compartment, left
- J285 - Control module with indicator unit in instrument panel insert
- K1 - Headlight High Beam Indicator Light
- K13 - Rear Fog Light Indicator Light
- K32 - Brake Pad Wear Indicator Light
- K47 - ABS Warning Light
- T1c - Single Connector, behind fuse/relay panel
- T2b - Double Connector
- T2c - Double Connector
- T2d - Double Connector

- T2e - Double Connector
- T31 - 31-Pin Connector, on ABS Control Module (w/EDL)
- T32 - 32-Pin Connector, blue
- T32a - 32-Pin Connector, green
- Y2 - Digital Clock
- (30) - Ground connection -1-, beside fuse/relay panel
- (C5) - Wire connection -1- (brake pad wear monitor), in left front wiring harness
- (C6) - Wire connection -2- (brake pad wear monitor), in left front wiring harness
- (C7) - Wire connection -3- (brake pad wear monitor), in left front wiring harness

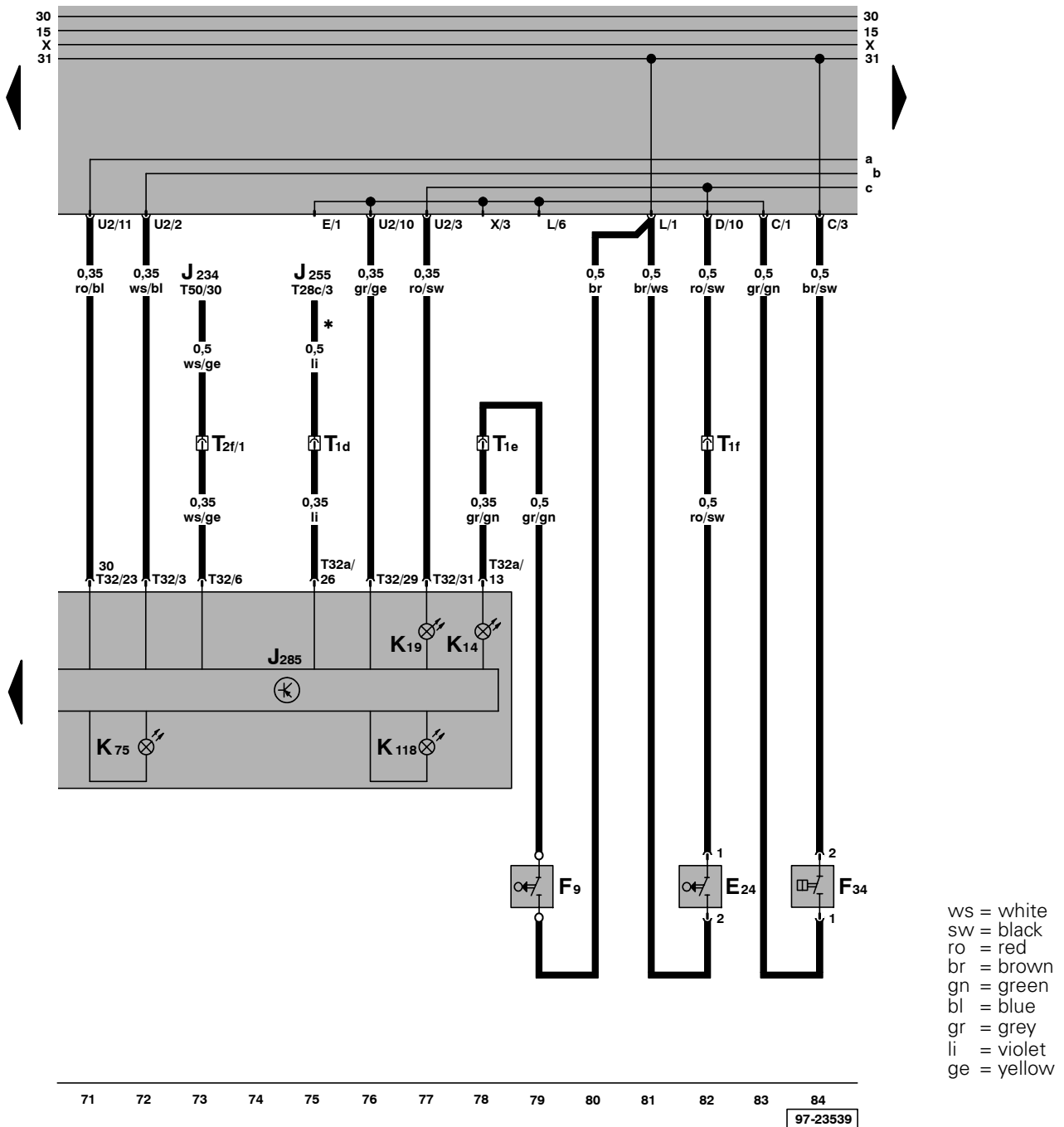

E24 - Left Seat Belt Switch
F9 - Parking Brake Warning Light Switch
F34 - Brake Fluid Level Warning Switch
J234 - Airbag Control Module
J255 - Climatronic Control Module
J285 - Control module with indicator unit in instrument panel insert
K14 - Parking Brake Indicator Light
K19 - Seat Belt Warning Light
K75 - Airbag Malfunction Indicator Lamp (MIL)
K118 - Warning light for brake system
T1d - Single Connector, behind fuse/relay panel
T1e - Single Connector, behind fuse/relay panel
T1f - Single Connector, behind fuse/relay panel
T2f - Double Connector, behind fuse/relay panel

T28c - 28-Pin Connector, on climatronic control module
T32 - 32-Pin Connector, blue
T32a - 32-Pin Connector, green
T50 - 50-Pin Connector, on airbag control module

* - Vehicles with Climatronic only

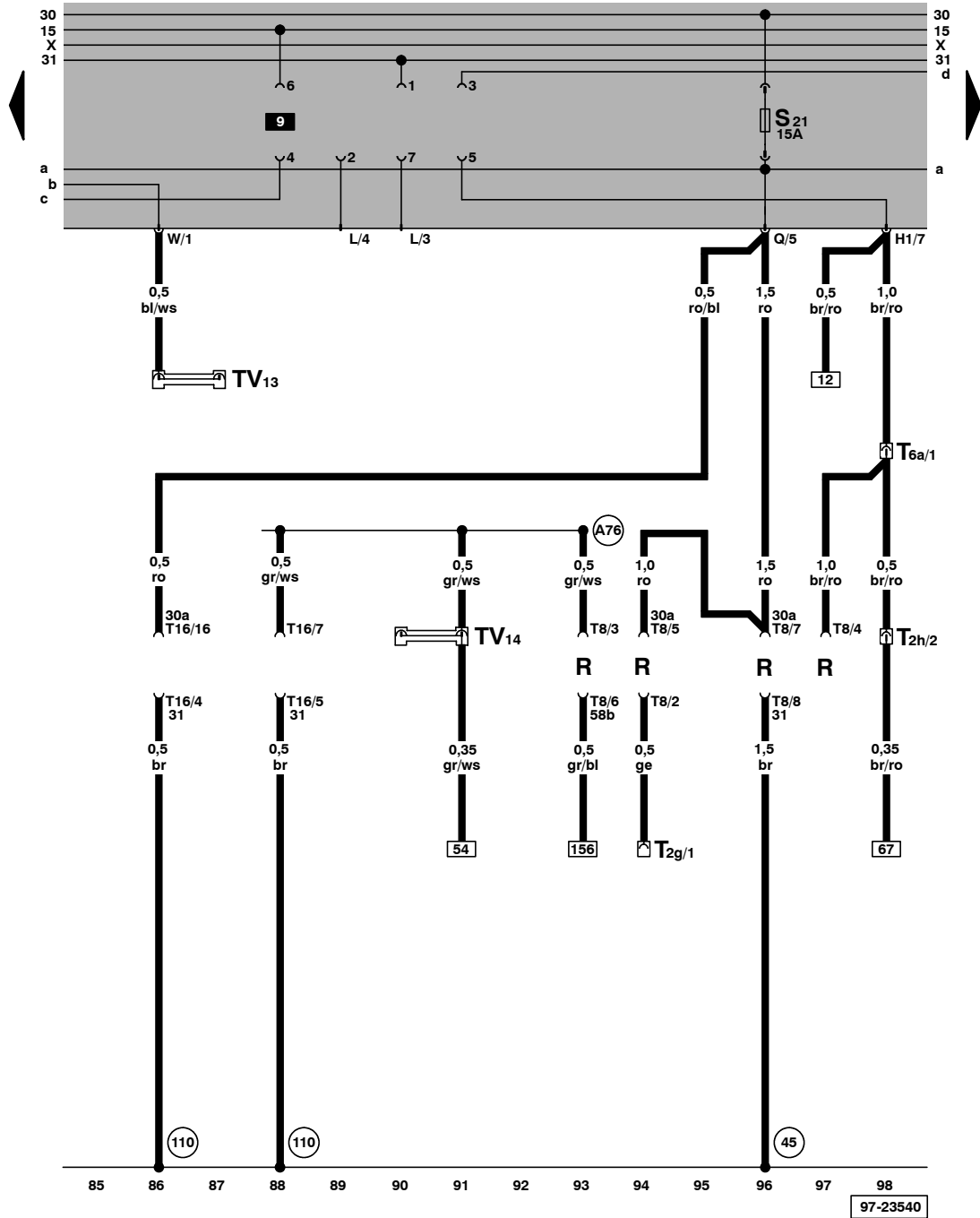

ws = white
 sw = black
 ro = red
 br = brown
 gn = green
 bl = blue
 gr = grey
 li = violet
 ge = yellow

- R - Radio
- T2g - Double Connector
- T2h - Double Connector, behind fuse/relay panel
- T6a - 6-Pin Connector, behind fuse/relay panel
- T8 - 8-Pin Connector
- T16 - Data Link Connector (DLC), behind steering column cover
- TV13 - Vehicle Speed Signal Wire Connector, blue
- TV14 - Data Link Connector (DLC) wire Connector, white

- (45) - Ground connection, behind instrument panel, center
- (110) - Ground connection -2-, in instrument panel wiring harness

(A76) - Connector (K-diagnosis wire) in instrument panel wiring harness

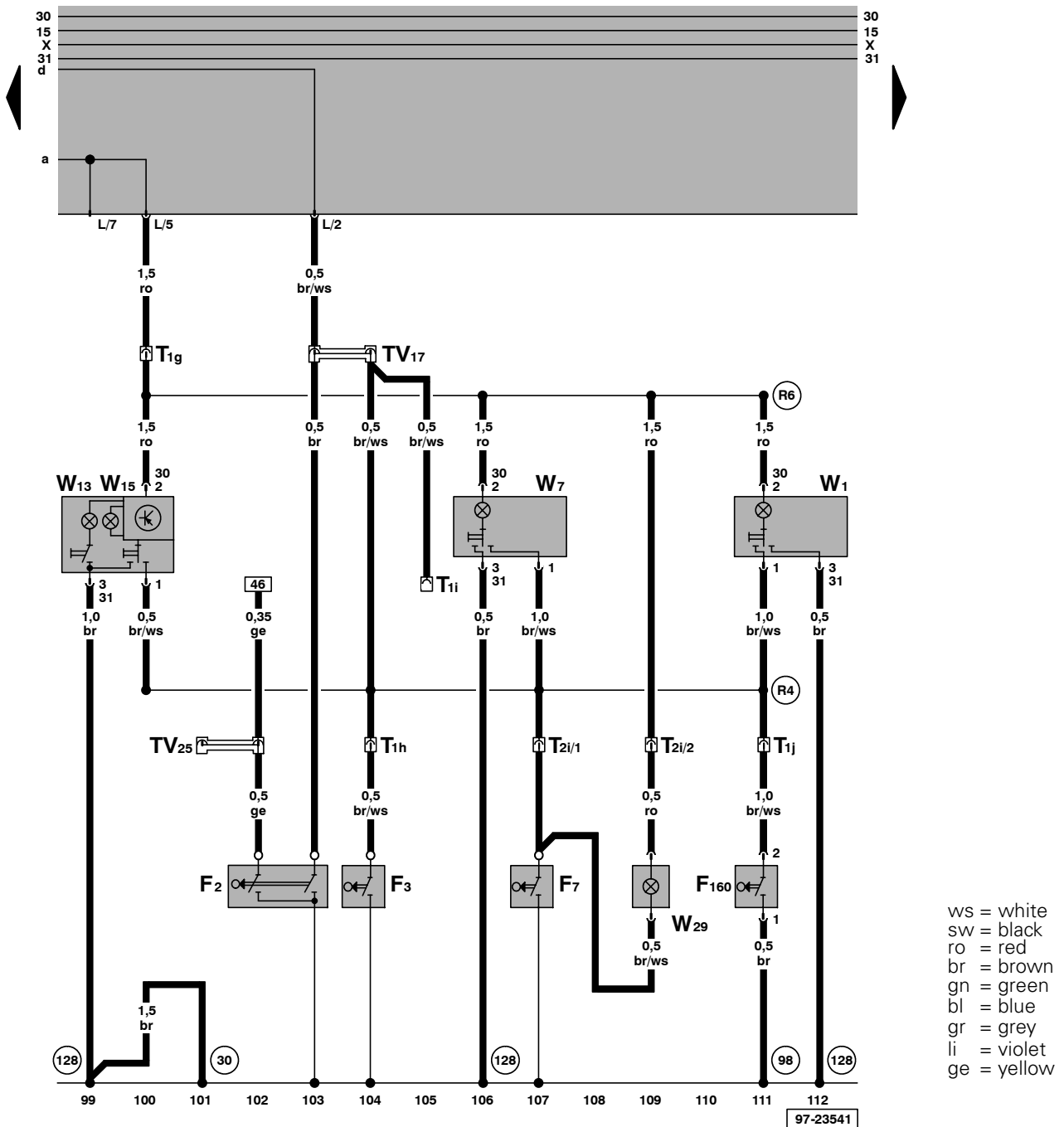

- F2 - Door contact Switch - Driver's side
F3 - Door contact switch-Passenger side
F7 - Right Rear Side/Sliding Door Contact Switch
F160 - Rear Lid Contact Switch
T1g - Single Connector, behind fuse/relay panel
T1h - Single Connector, behind instrument panel, right
T1i - Single Connector, behind fuse/relay panel
T1j - Single Connector, near taillamp assembly
T2i - Double Connector, near interior light, center
TV17 - Door Contact Switch Wire Connector, brown
TV25 - Door Contact Switch Wire Connector, pink
W1 - Interior light, front
W7 - Center Interior Light
W13 - Right Front Map/Reading Light
W15 - Interior Light with Delay Switch

W29 - Running board light

- (30) - Ground connection, -1-, beside fuse/relay panel
(98) - Ground connection, in rear lid wiring harness
(128) - Ground connection -1-, in interior light wiring harness
(R4) - Wire connection -1-, in interior light/door contact switch wiring harness
(R6) - Plus connection -1-, in interior light wiring harness

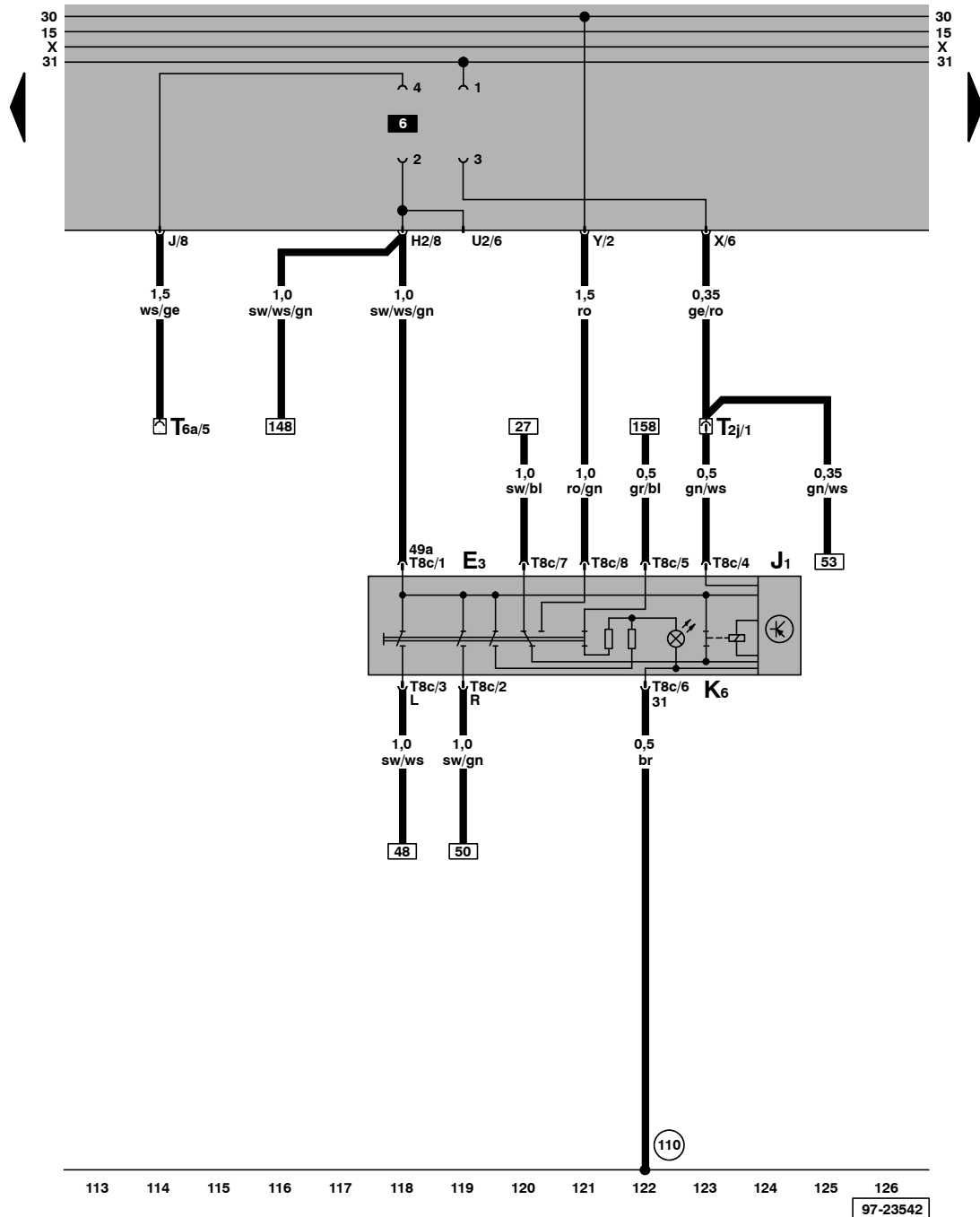

ws = white
 sw = black
 ro = red
 br = brown
 gn = green
 bl = blue
 gr = grey
 li = violet
 ge = yellow

- E3 - Emergency Flasher Switch
- J1 - Turn Signal Relay
- K6 - Indicator light for emergency flasher system
- T2j - Double Connector, behind fuse/relay panel
- T6a - 6-Pin Connector, behind fuse/relay panel
- T8c - 8-Pin Connector

(110) - Ground connection -2-, in instrument panel wiring harness

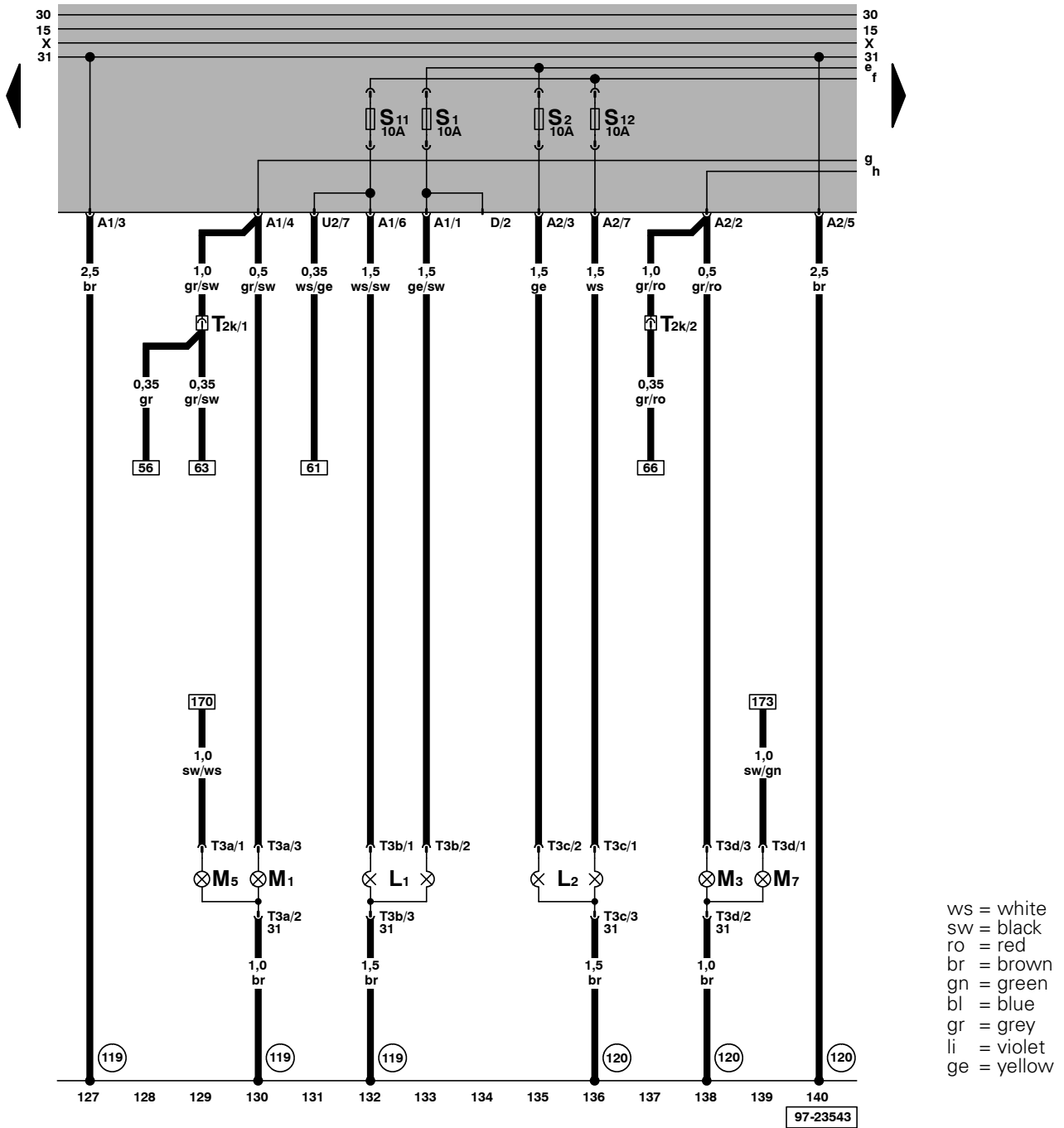

ws = white
 sw = black
 ro = red
 br = brown
 gn = green
 bl = blue
 gr = grey
 li = violet
 ge = yellow

- L1 - Left Headlight
- L2 - Right Headlight
- M1 - Left Parking Light
- M3 - Right Parking Light
- M5 - Left Front Turn Signal Light
- M7 - Right Front Turn Signal Light
- T2k - Double Connector, behind fuse/relay panel
- T3a - 3-Pin Connector
- T3b - 3-Pin Connector
- T3c - 3-Pin Connector
- T3d - 3-Pin Connector

- (119) - Ground connection -1-, in headlight wiring harness
- (120) - Ground connection -2-, in headlight wiring harness

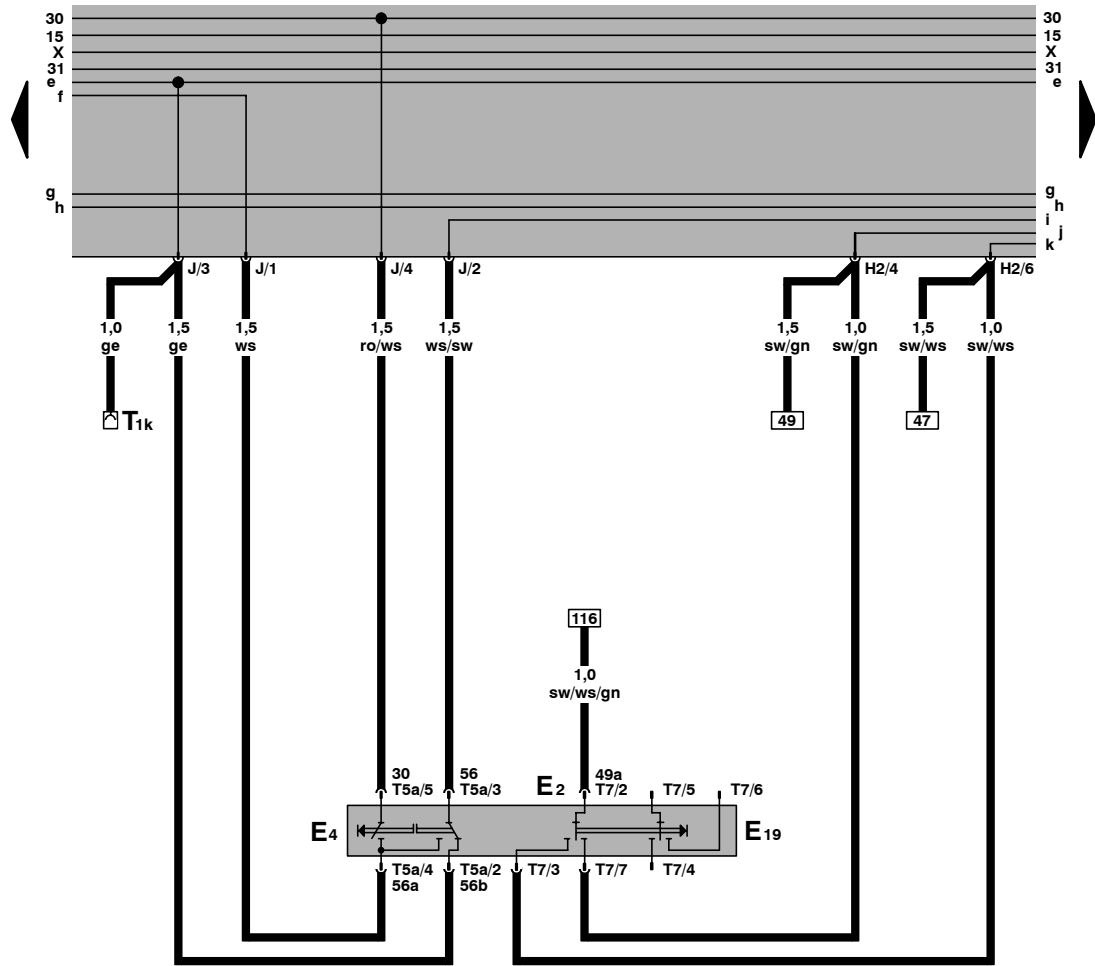

ws = white
 sw = black
 ro = red
 br = brown
 gn = green
 bl = blue
 gr = grey
 li = violet
 ge = yellow

141	142	143	144	145	146	147	148	149	150	151	152	153	154
													97-23544

- E2 - Turn signal switch
- E4 - Headlight Dimmer/Flasher Switch
- E19 - Park Light Switch
- T1k - Single Connector, behind fuse/relay panel
- T5a - 5-Pin Connector, behind steering column switch cover
- T7 - 7-Pin Connector, behind steering column switch cover

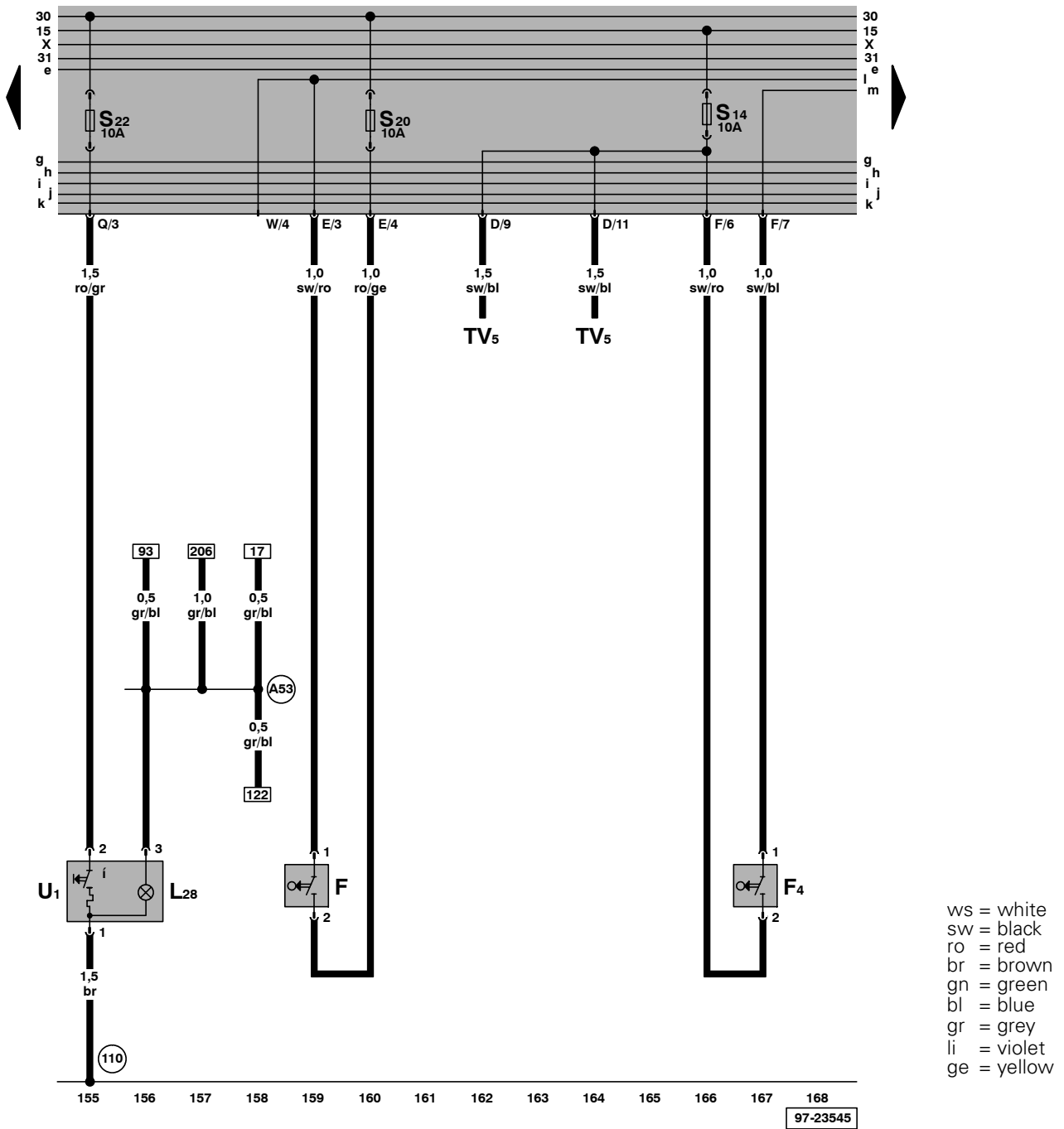

- F - Brake Light Switch
- F4 - Back-Up Light Switch
- L28 - Cigarette Lighter Light
- TV5 - Terminal 15a Wire Connector, green, 4-Pin and 8-Pin
- U1 - Cigarette Lighter
- (110) - Ground connection -2-, in instrument panel wiring harness
- (A53) - Plus connection (58b), in instrument panel wiring harness

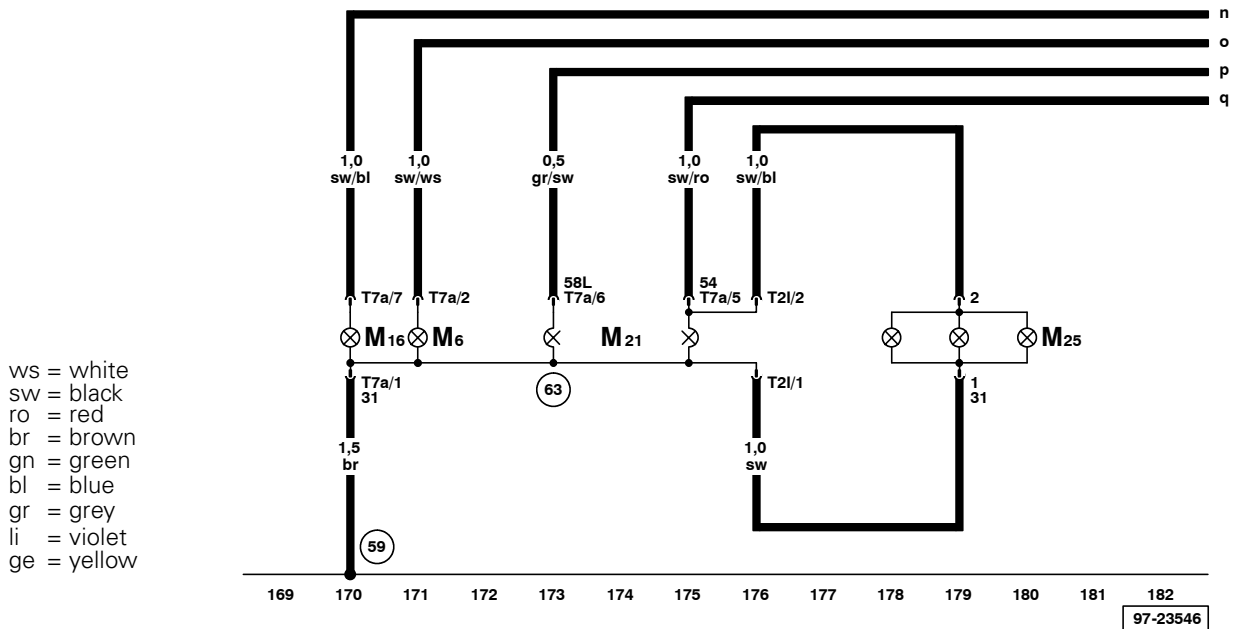
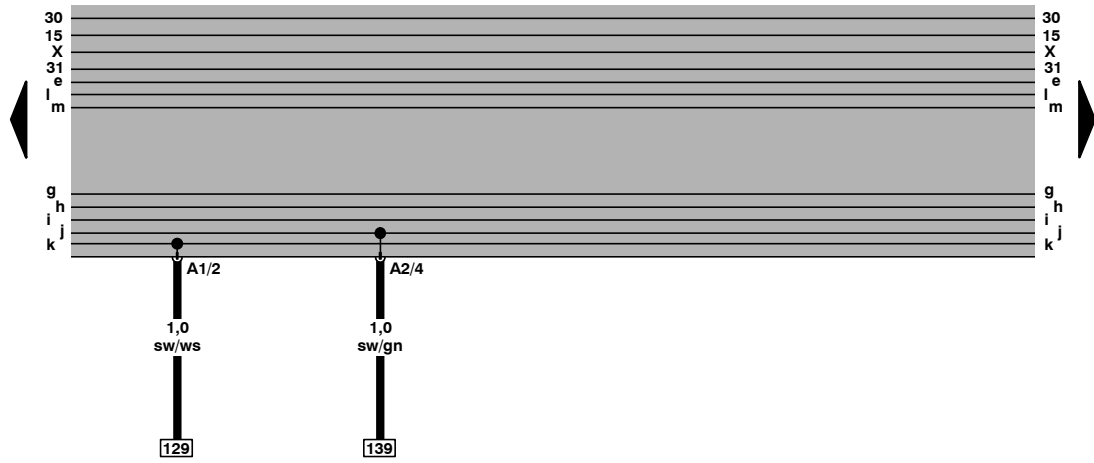

- M6 - Left Rear Turn Signal Light
- M16 - Left Back-Up Light
- M21 - Left Brake/Tail Light
- M25 - High-mount Brake Light
- T2l - Double Connector
- T7a - 7-Pin Connector
- 59 - Ground connection, near taillight, left
- 63 - Ground connection, on left taillight bulb holder

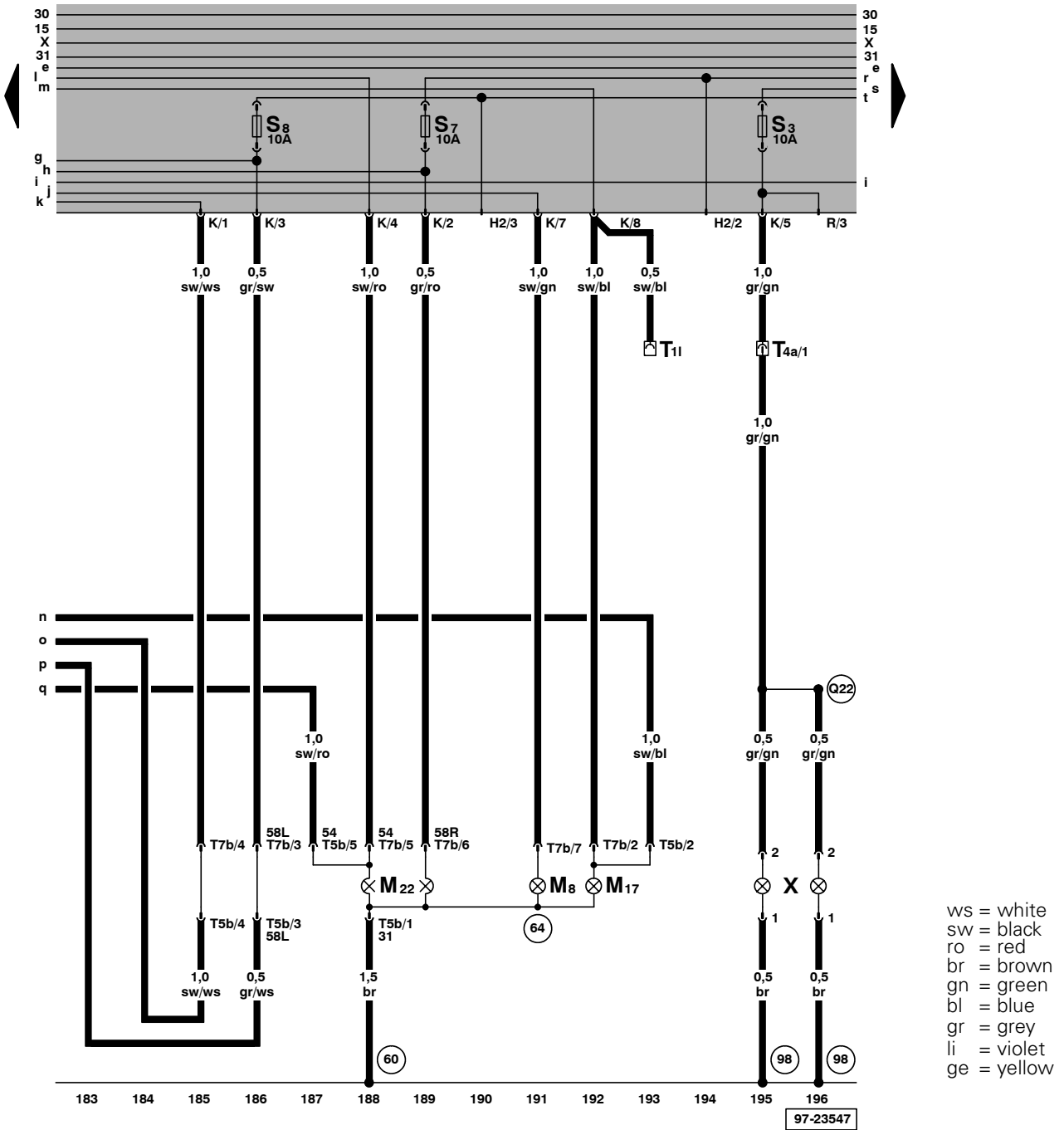

- M8 - Right Rear Turn Signal Light
- M17 - Right Back-Up Light
- M22 - Right Brake/Tail Light
- T11 - Single Connector, behind fuse/relay panel
- T4a - 4-Pin Connector, near taillamp assembly
- T5b - 5-Pin Connector
- T7b - 7-Pin Connector
- X - License Plate Light

Q22 - Wire connection -1-, in rear lid wiring harness

- 60 - Ground point -2- near taillamp assembly, right
- 64 - Ground connection, on right taillight bulb holder
- 98 - Ground connection, in rear lid wiring harness

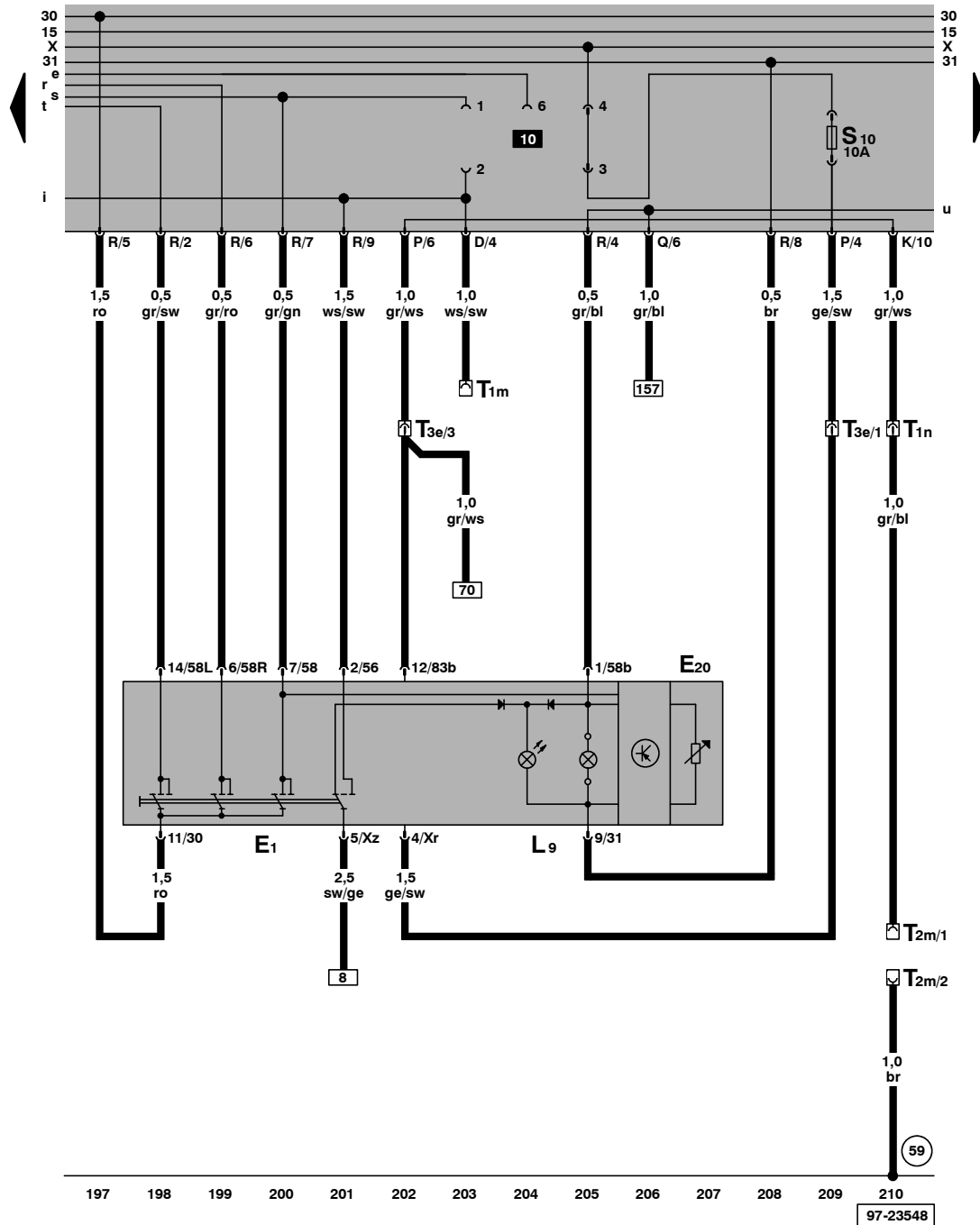

ws = white
 sw = black
 ro = red
 br = brown
 gn = green
 bl = blue
 gr = grey
 li = violet
 ge = yellow

- E1 - Light switch
- E20 - Instrument Panel Light Dimmer Switch
- L9 - Headlight Switch Light
- T1m - Single Connector, behind fuse/relay panel
- T1n - Single Connector, near taillamp assembly
- T2m - Double Connector
- T3e - 3-Pin Connector, behind fuse/relay panel
- (59) - Ground connection, near taillight, left

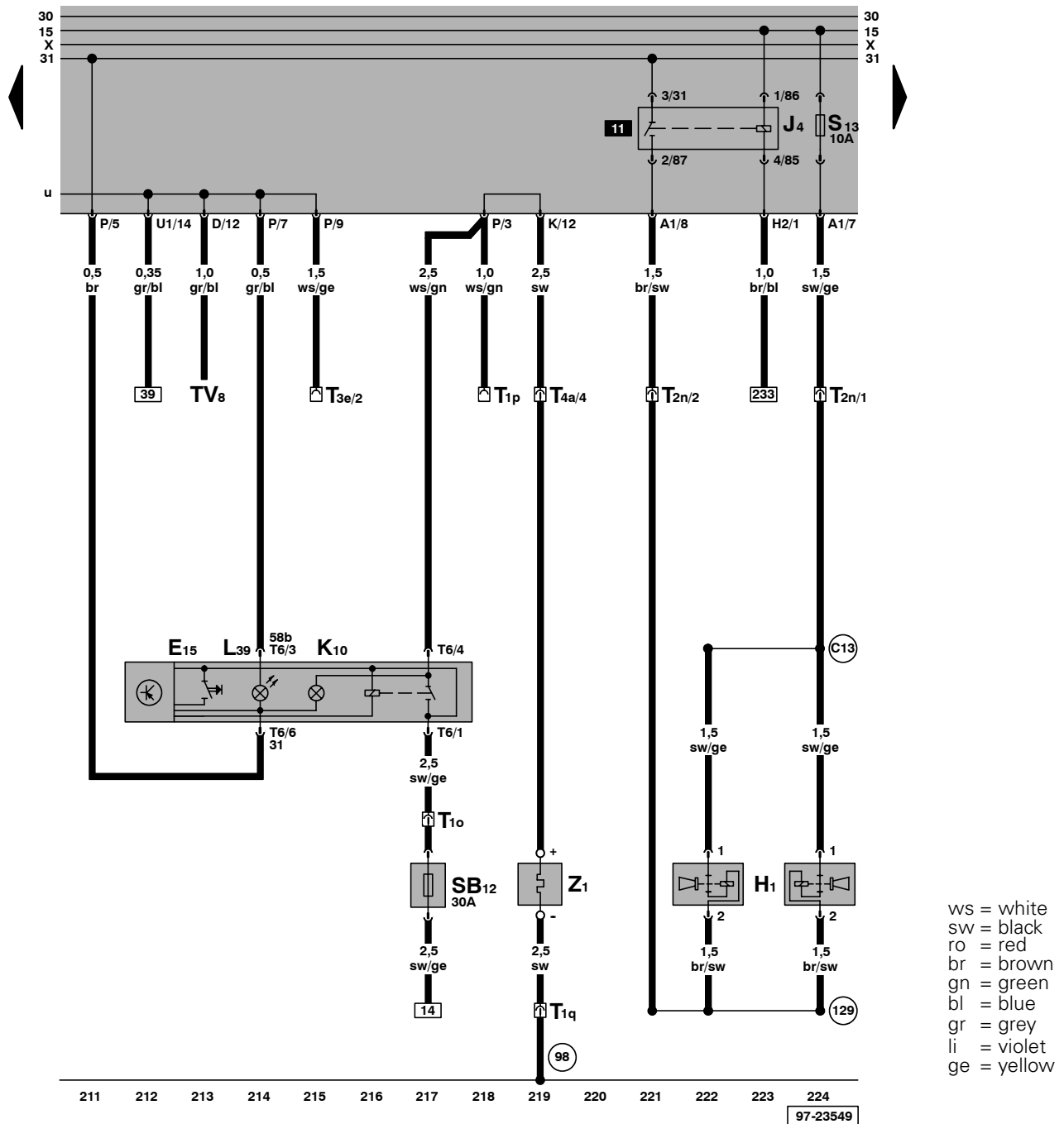

- E15 - Rear window defogger switch
- H1 - Dual tone horn
- J4 - Dual Horn Relay
- K10 - Indicator light for heated rear windshield
- L39 - Rear Window Defogger Switch Light
- SB12 - Fuse 12 in fuse holder, below relay panel
- T1o - Single Connector, behind fuse/relay panel
- T1p - Single Connector, behind fuse/relay panel
- T1q - Single Connector, in rear lid
- T2n - Double Connector, in engine compartment, left front
- T3e - 3-Pin Connector, behind fuse/relay panel
- T4a - 4-Pin Connector, near taillamp assembly
- T6 - 6-Pin Connector
- TV8 - Terminal 58b Wire Connector, grey
- Z1 - Heated rear window

- (98) - Ground connection, in rear lid wiring harness
- (129) - Ground connection, in dual-tone horn wiring harness
- (C13) - Plus connection, in dual tone horn wiring harness

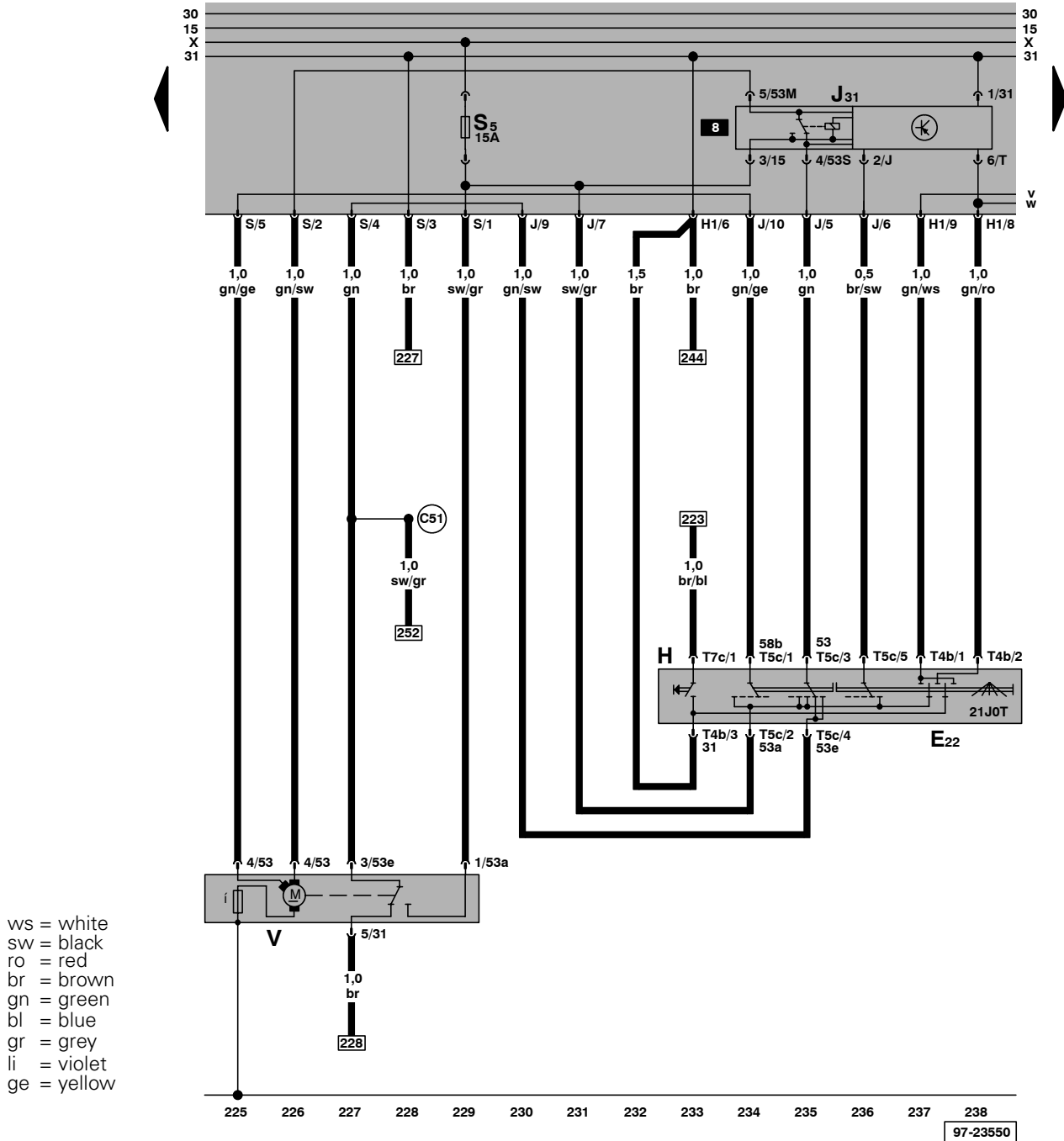

- E22 - Windshield Wiper/Washer Switch
- H - Signal horn activation
- J31 - Wiper/Washer Intermittent Relay (programmable)
- T4b - 4-Pin Connector, behind steering column switch cover
- T5c - 5-Pin Connector, behind steering column switch cover
- T7c - 7-Pin Connector, behind steering column switch cover
- V - Windshield Wiper Motor
- (C51) - Plus connection (x), in wiper motor wiring harness

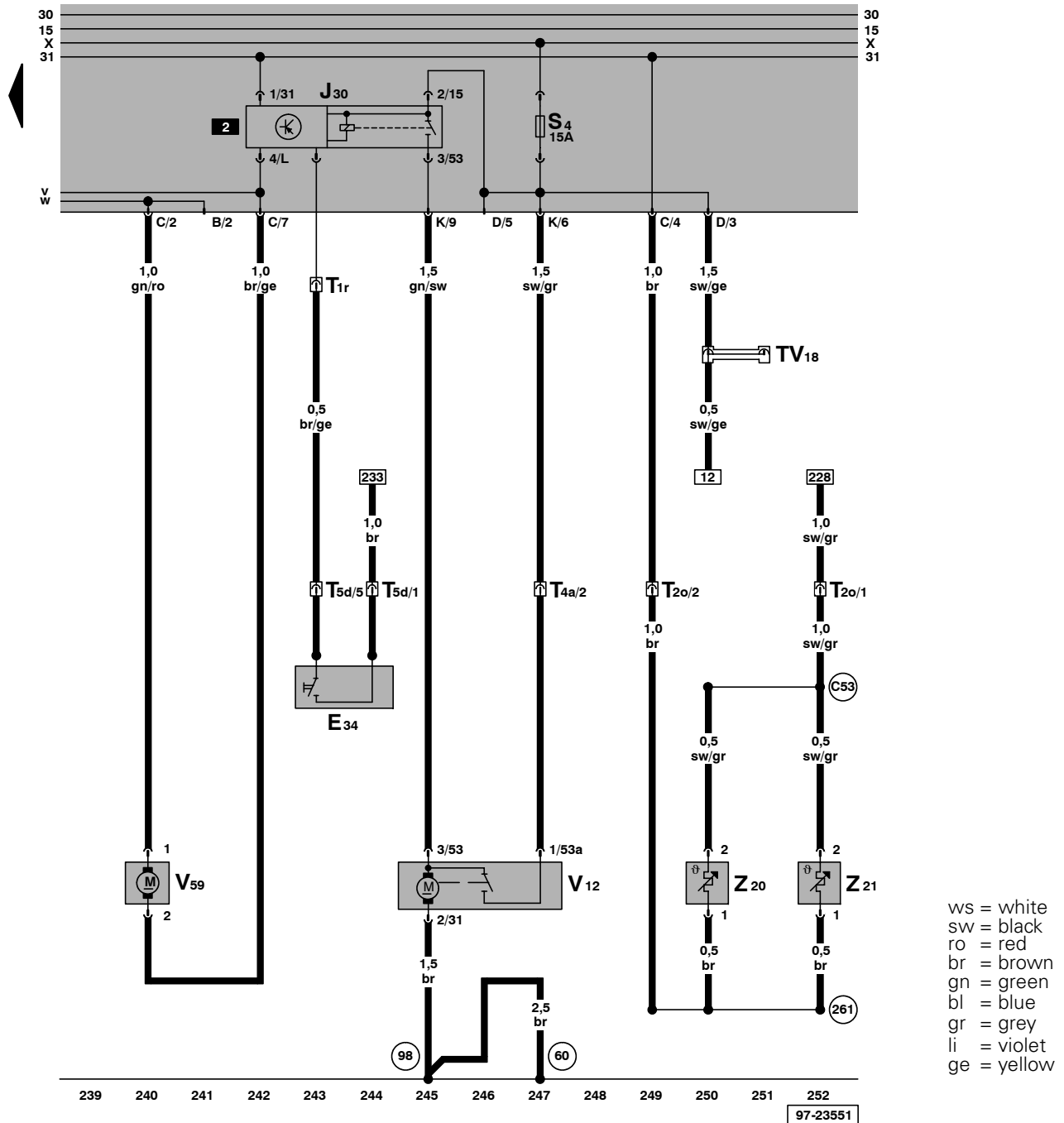

- E34 - Rear Window Wiper Switch
 - J30 - Rear Window Wiper/Washer Relay
 - T1r - Single Connector, on rear window wiper/washer relay
 - T2o - Double Connector, on firewall, right
 - T4a - 4-Pin Connector, near taillamp assembly
 - T5d - 5-Pin Connector, behind steering column switch cover
 - TV18 - Terminal Xa Wire Connector, violet
 - V12 - Motor for rear windshield wiper
 - V59 - Windshield and Rear Window Washer Pump
 - Z20 - Left Washer Nozzle Heater
 - Z21 - Right Washer Nozzle Heater
- (60) - Ground point -2- near taillamp assembly, right

- (98) - Ground connection, in rear lid wiring harness
- (261) - Ground connection, in wiring harness heated spray jet
- (C53) - Plus connection (x) in wiring harness heated spray jet